



"Supplied And Installed,
Direct from the Manufacturer"

**UPGRADE
FOR
NO COST!***

SwiftConnect
Makes Installations
Swift & Fast.



ECOGENICA

WARNING

This unit requires reliable earthing before usage, otherwise this may result in injury or death.



Do not install this if you cannot ensure that the power supply to the property is properly grounded.

The device must be installed by a licensed professional and must meet the following conditions:

- Complies with AS/NZS 3500.4 - "National plumbing and drainage systems. Part 4.2: Hot water supply systems. Acceptable schemes";
- Compliant with AS NZS 3000-Electrical Wiring Rules;
- comply with the rules and regulations of the local authority;
- In line with national building regulations;
- local occupational health and safety regulations;

NOTICE TO CUSTOMERS

This air source water heater must be installed and maintained by licensed professionals in accordance with building regulations.

Only licensed professionals will issue you a certificate of compliance certifying that the work in question meets all relevant standards, and only licensed professionals will take out craft insurance.

Please read and understand this manual. If you have any questions, please contact our

WARNING

Hot water burns! For safety, small children should be supervised around hot water appliances.

Heat pump water heaters can store water at temperatures that cause scalding, and water temperatures over 50 degrees Celsius can cause scalding, so care must be taken to ensure that damage is not caused by improper use of the water heater.

Since heat pump water heaters can generate water temperatures in excess of 50 degrees Celsius, regulations require that a regulating valve be installed on the hot water outlet line of the water heater to prevent the water temperature from exceeding a pre-set safety upper limit. When installing or retrofitting an existing system, the installation must be performed by an authorized plumber.

Care should be taken to avoid contact with any plumbing or fixtures associated with the water heater plumbing. Under no circumstances should "home craft" type modifications be attempted.

This appliance is not intended for use by persons (including children) with reduced physical sensory or intellectual abilities, or who lack the experience and knowledge to safely use this appliance without supervision or instruction. Children should be supervised by a responsible person to ensure their personal safety.

The hot water pump power supply must be protected by a separate circuit breaker on the main power switch board and rated to suit the size of the components. Do not connect other appliances, especially high-power appliances, to the main power supply of the water heater, so as not to affect the normal use of the water heater.

||Directory Guidelines

<u>The first part: product info</u>	<u>3-5</u>
<u>The second part: safety info</u>	<u>6</u>
<u>The third part: before installation</u>	<u>7</u>
<u>The fourth part: installation</u>	<u>8-11</u>
<u>The fifth part: debugging</u>	<u>12-13</u>
<u>The sixth part: operation</u>	<u>13-16</u>
<u>The seventh part: trouble removal</u>	<u>16-26</u>
<u>The eighth part: maintenance</u>	<u>26-28</u>
<u>The ninth part: guarantee</u>	<u>28-30</u>

1 | product info

1-1 diagram

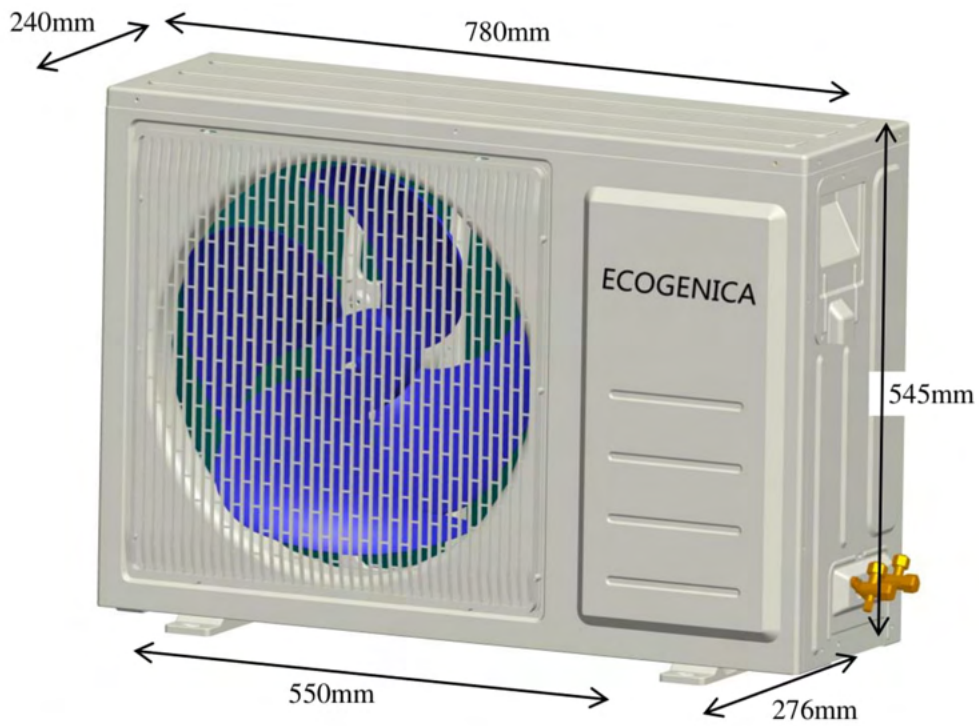

1-2 components

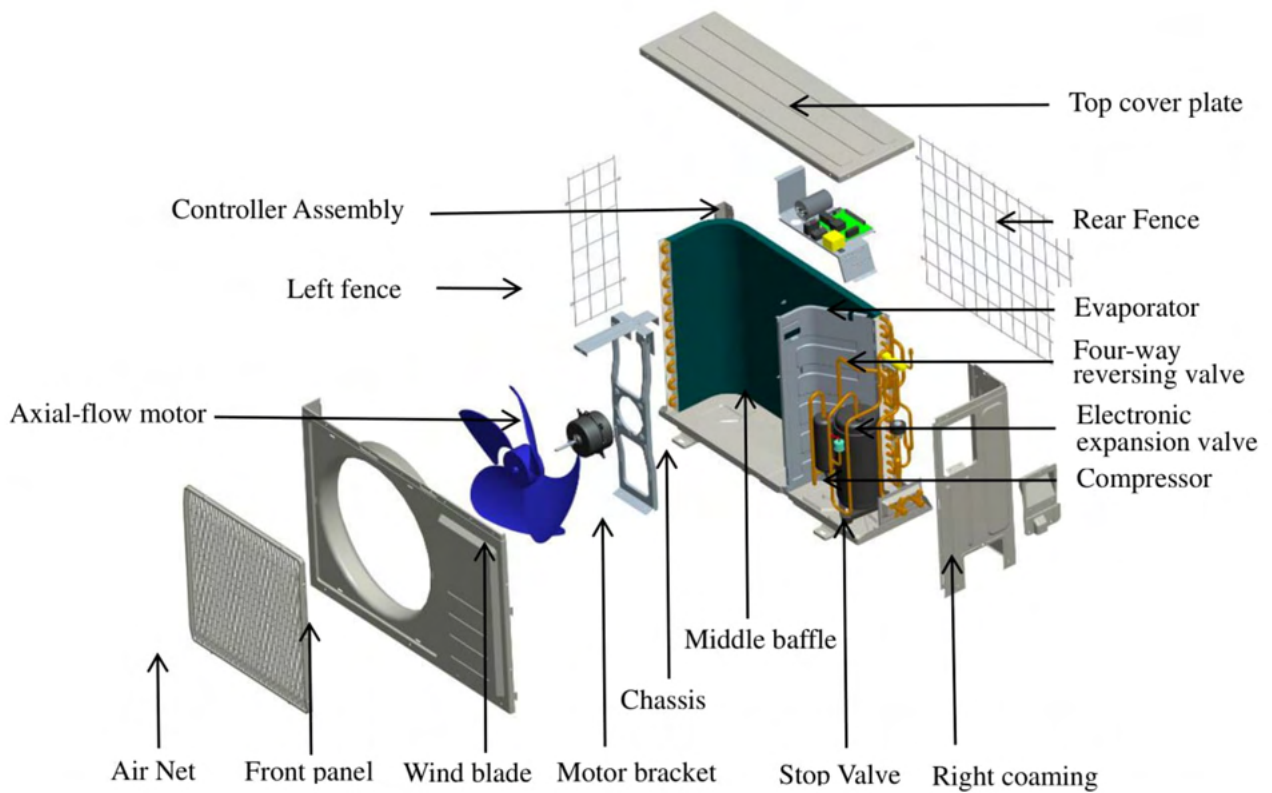

1-3 tank (mm)

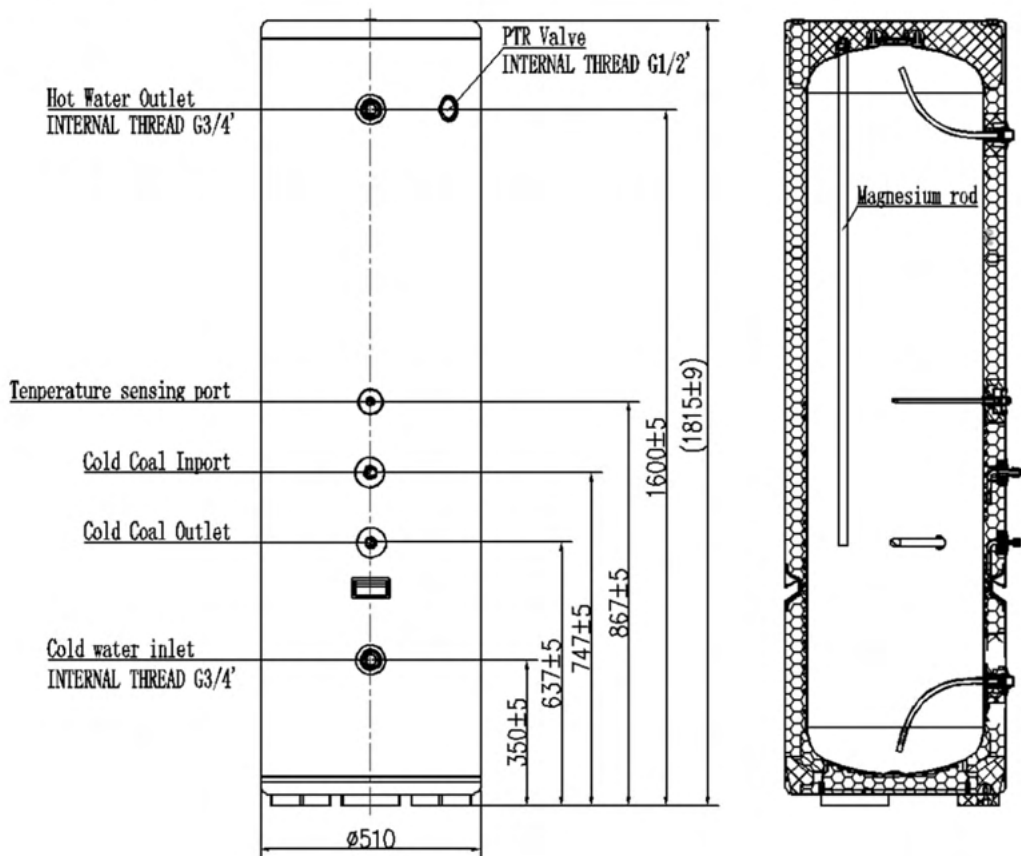

1-4 parameters

MODEL	EG-215F
Refrigerant type	R410a
Mass volume	1280g
Running ambient air temp.	-7~+40°C
Setting Outlet water temp	35~60°C (1°C step)
Product weight	36kg
Tank weight	70kg
Thermal capacity	3500W
Average input power	786W
COP	4.45
Max power input	1250W
Circuit Breaker Size	5.43
Design Pressure (High/Low)	4.4/0.6MPa
Protection Raining Class	IPX4
Rated Pressure	500kPa
PTR Valve	850kPa

test condition:

1. default setting: 55 °C
2. Test conditions: outlet water temperature 55 °C, inlet water temperature 14 °C, dry bulb temperature 19 °C, wet bulb temperature 15 °C

1-5 circuit diagram

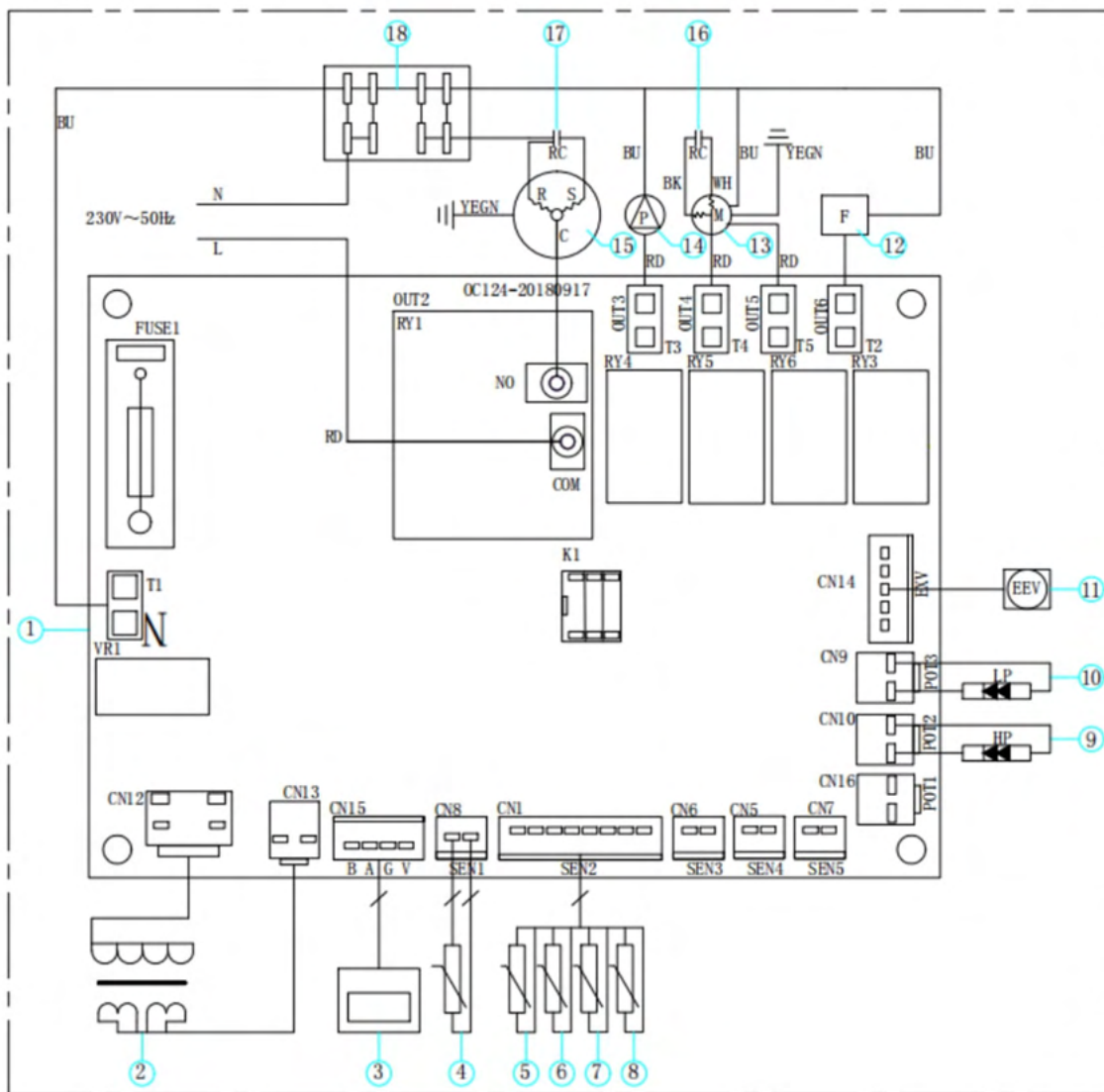

① Integrated Circuit Board

② Transformer

③ Display

④ Water tank temperature sensor

⑤ Exhaust Temperature Sensor

⑥ Ambient Temperature Sensor

⑦ Gas recovery temperature sensor

⑧ Coiler temperature sensor

⑨ High-pressure switch

⑩ Low-pressure switch

⑪ Electronic expansion valve

⑫ Four-way reversing valve

⑬ Motor

⑭ Water pump

⑮ Compressor

⑯ Motor capacitance

⑰ Compressor startup capacitor

⑱ Connection terminal station



2 | safety info

Please read all manuals carefully before installing and operating this unit.

The following safety warnings are very important, always read and obey all safety signs

warning

- The device must be effectively grounded; • RCD circuit breaker must be installed;
- Do not remove, cover or damage any permanent instructions or labels from the exterior or interior of the unit panel;
- Only qualified personnel should install in accordance with local and national regulations and this guide;
- Improper installation may cause water leakage, electric shock or fire alarm;
- All electrical connections must comply with the requirements of the local power company, the local power company and this guide;
- Do not use rated fuse, otherwise it may malfunction and cause electrical fire;
- Do not insert fingers, rods or other objects into the air inlet or outlet. The fan is rotating at high speed, which may cause injury;
- Do not use flammable sprays, such as hairspray or paint, near the machine to avoid fire;
- Disposal: Do not dispose of electrical appliances as unsorted municipal waste. A separate collection facility should be used. Contact your local government to find out Information about the collection system. If electrical appliances are disposed of in landfills or dump site, where hazardous substances can seep into groundwater and cause health problems question;
- The unit must be fixed firmly, otherwise noise and vibration may be generated;
- Make sure there are no obstacles around the device;
- In places with strong wind (such as seaside areas), the unit should be installed in a windproof place;
- The PTR valve is operated every 6 months to ensure that the valve does not have any any restrictions. The drain pipe should be well insulated to prevent the water in the pipe from freezing in cold weather;

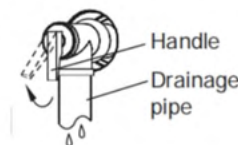

cautious

- The ground electrode must be well grounded.
Make sure all electrical sockets and plugs are dry and tightly connected;
- Before cleaning, be sure to stop operation and isolate the unit (ie, turn off the isolating switch or circuit breaker). Otherwise, electric shock and injury may occur;
- Water temperature over 50 degrees Celsius will cause severe burns and even death. Children, the disabled and the elderly are at the highest risk of burns.
in the bath or feel the water temperature with your hands before showering to avoid burns;
- Do not operate the machine with wet hands to avoid electric shock.
- A one-way check valve and a suitable isolation valve must be installed on the water inlet side.
- It is normal for the one-way safety valve to release some water during operation.
However, if there is a large amount of water, please contact our service team
Further advice. Arrange drain pipes to ensure efficient drainage. Improper drainage can cause water damage to surrounding areas such as buildings, furniture etc.
- Except for repair and maintenance purposes, do not turn off the power, especially in cold weather, as it may freeze the machine when the power is turned off. Continuously powered heating Water is necessary.



3 | before installation

3-1 disassemble

When unpacking, make sure that the items in the accessories list are complete, and whether the model of the main unit and the water tank are correctly matched

3-2 transport

When shipping this item, the following rules must be followed:

1. When moving, do not make the fuselage deviate from the vertical angle by more than 25 Degrees. keep vertical;
2. To avoid scratches or damage, please use protective covering where applicable;
3. Since the machine is heavy, it needs two or more people to carry it, to avoid injury and/or damage;

3-3 position requirement

When choosing a suitable location, the following factors should be considered:

4. Ensure that there is enough space for installation and future maintenance;
5. The inlet and outlet should be free of obstacles and strong winds;
6. The bottom surface should be flat (ie no more than 2° inclination), and can bear 3 times the weight of the machine, while ensuring that no noise and/or vibration will be increased;
7. The running noise and the exhausted airflow should not affect other people;
8. Make sure there is no flammable gas nearby;
9. The installation location should be convenient for piping and wiring;
10. Installation indoors may cause indoor temperature fluctuations and excessive noise;
11. If the device must be installed in the metal part of the building, it should be ensured that the electrical insulation complies with the relevant local standards;

Securely secure the device to help avoid unnecessary noise and/or vibration;

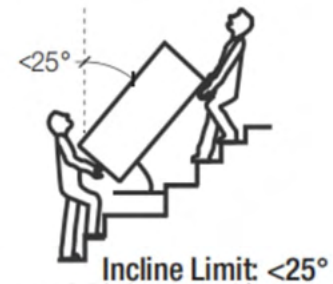

cautious

- The ambient air temperature must also be taken into account.

The heat pump operates at ambient air temperature between -7°C and 40°C , below or above this range, the heat pump will not operate;

- If it is installed in closed spaces such as garages and basements, there must be unrestricted air flow (such as installing a strong exhaust fan) to ensure the

The temperature is not lower than the specified range of the machine to prevent freezing;

Installing this unit in any of the following locations may cause malfunction (consult your representative before purchasing).

- Mineral oil (e.g., lubricant for cutting machines).
- Seaside areas or places with salt in the air.
- Hot spring areas with corrosive gases (e.g., sulfides).
- Factories with large voltage fluctuations.
- In a cabin without a large enough exhaust system.
- Places exposed to direct sunlight or other sources of high heat.

(If there is no way to avoid these, a lid may be required).

- Where oil may seep into the system (e.g., kitchen).
- Areas with strong electromagnetic fields.
- Areas where flammable gases or materials are present.
- Areas where acidic or alkaline gases are present.
- Other special environments.

4 | The installation

4-1 Piping drawing

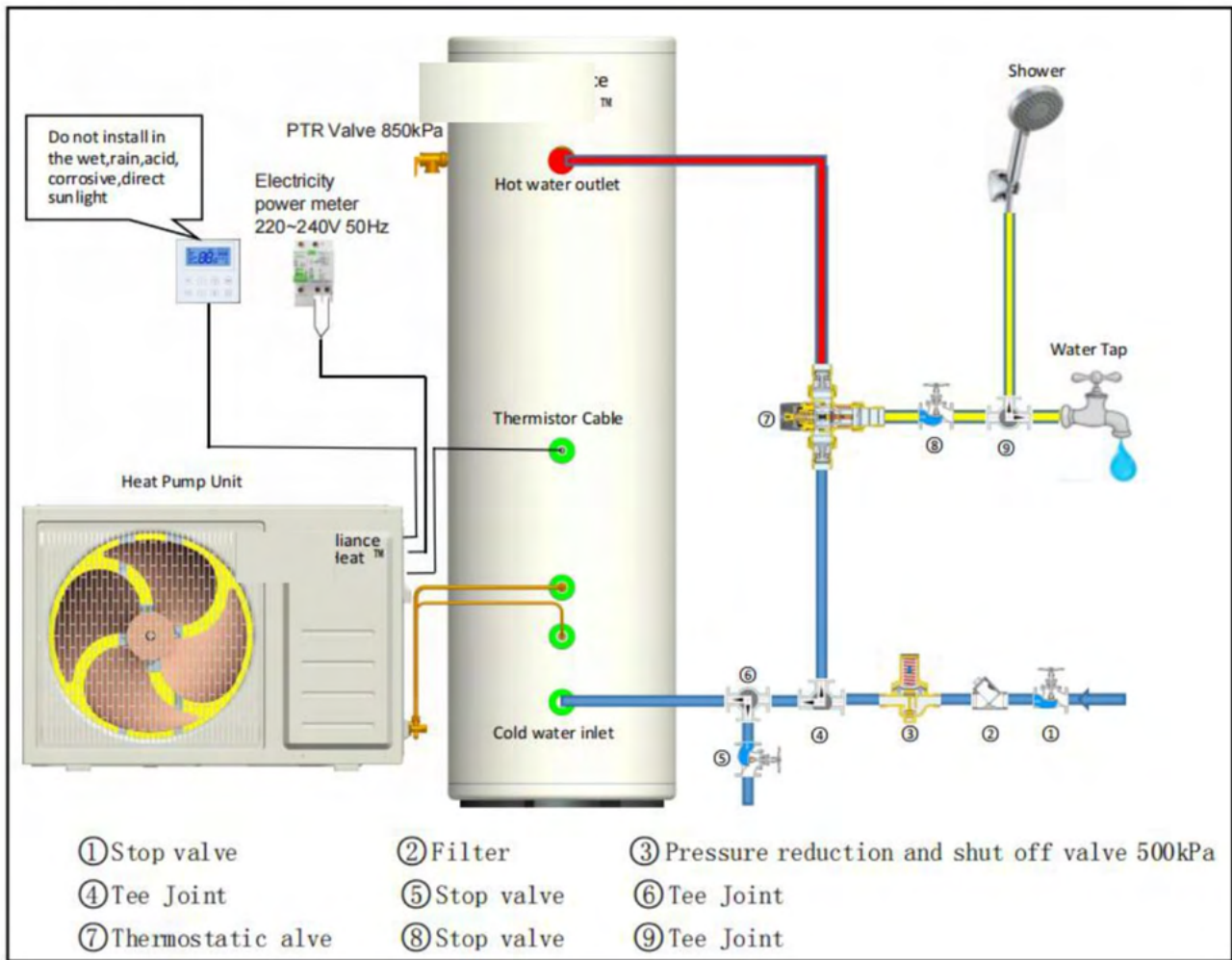

notice

- Cold water inlet and hot water outlet are 3/4 inch (20mm) female connections.
- The outlet of the PTR valve is a 3/4 inch (20 mm) female fitting.
- All hot water pipes must be insulated for safety and insulation.

cautious

- If the outdoor temperature is lower than 5 degrees Celsius during installation, insulation protection must be provided for hydraulic components (ie pipes).
- If the water inlet pressure is less than 150 kPa, a booster pump should be installed at the water inlet.
- To ensure the safe use of the water tank, when the water inlet pressure exceeds 500 kPa, a pressure reducing valve should be installed on the water inlet pipe.

warning

- Do not disassemble the PTR valve.
- Do not block the condensate drain line.

4-2 install position

Install properly spaced air circulation and duct passages

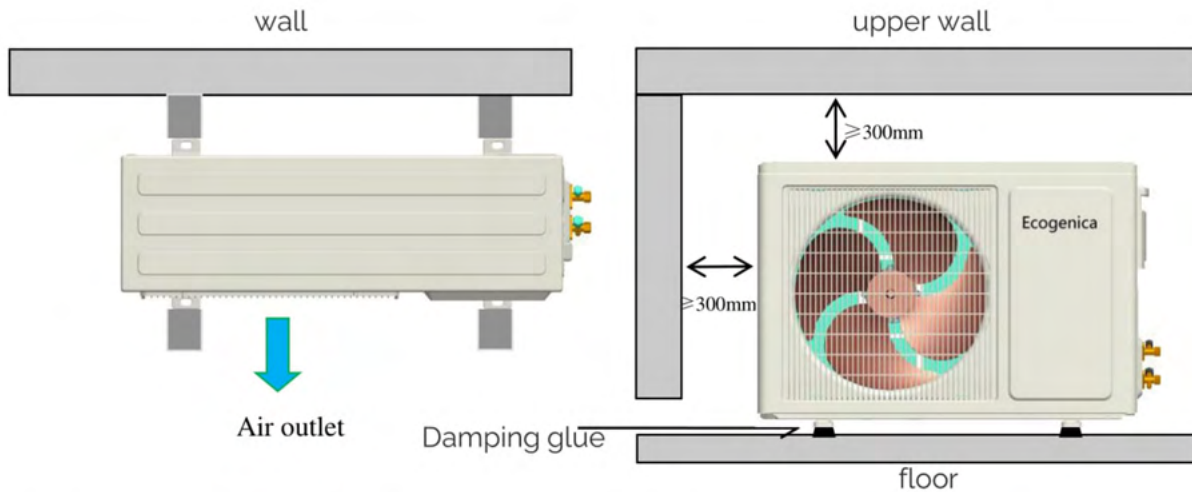

1. Place the device on a flat, firm surface capable of bearing 3 times the weight of the device.
 2. The distance within 2m from the air outlet, please do not pile up obstacles, which will affect the smooth air circulation (should avoid the windward direction).
 3. The control panel should not be installed in the bathroom, so as not to affect the normal work;
 4. If there is no special drainage pipe (sink), be sure to ensure that the condensed water flowing on the ground can be drained smoothly to avoid water pollution to the environment.
 5. We strongly recommend to have protective devices around the fuselage to keep children away from the heat pump.
 6. The outdoor unit is installed with a 25mm high rubber shockproof, and it is firmly fixed with studs.
- Avoid noise or fall off when the machine is running

4-3 Water tank installation position (as shown on the

1. The water storage tank must be placed upright on the ground, with a foot pad under it.
The installation site has a solid foundation and must be able to withstand a weight of more than 500kg. Not to be hung on the wall.
2. If the water storage tank is installed outdoors, please use bolts firmly prevent typhoon weather.
Air blowing down damages or injures personnel.

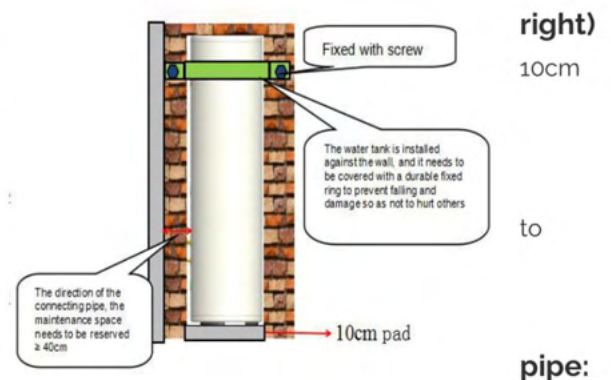

4-4 working fluid pipe [Specification of working fluid

gas pipe 3/8" (φ9.52), liquid pipe 1/4" (φ6.35)]

According to the installation site, the distance between the water heater and the water storage tank should not be greater than the length of the connecting pipe (the standard length of the connecting pipe is 1 meter).

1. Both ends of the working fluid pipe are blocked with plugs or sealed with plastic bags. If they are not connected, please do not disassemble them in advance to prevent dust, impurities or water from entering.
2. If it is disassembled in advance, please clean it with high pressure nitrogen gas before connecting.
3. When connecting the water tank, please check whether the sealing nut of the water tank has fallen off, otherwise, use high-pressure nitrogen to clean the fluorine system channel.
4. When connecting to the host end, a suitable wrench must be used to hold the proper position of the globe valve, and another wrench must be used to hold the movable nut and lock it.
to prevent it from rotating and damage other parts.
5. The strength is properly controlled to prevent the screws from slipping

⚠️ cautions

both ends of the working medium tube should be well protected.
The contact surface is flat without unevenness, otherwise there will be leakage

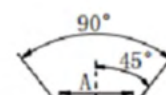

The bell mouths at

Risk of leakage of refrigerant (pictured right).

OD (mm)	A (mm)	
	Max	Min
Φ6.35	8.7	8.3
Φ9.52	12.4	12.0

4-5 Vacuum (as shown below)

When starting vacuuming, pay attention to:

- 1) Check whether the pointer of the pressure gauge returns to zero. If it does not point to zero, please use it again.
- 2) If the pointer of the pressure gauge points to vacuum quickly, please check whether the valve of the pressure gauge is open.

Vacuumping process:

The specific time for vacuuming is about 20-30min, which is subject to the pointer of the pressure gauge $\leq -0.1\text{MPa}$; first close the low-pressure valve of the pressure gauge and then close the vacuum pump.

Note: The vacuuming time must be judged when the pointer of the pressure gauge is less than or equal to -0.1MPa . Pressure maintenance: observe the pointer of the pressure gauge for 5 minutes to see if the pointer rotates.

If the system pressure leakage is greater than -0.08MPa , it means that the system has leakage; if there is leakage, it is necessary to check the possible leakage points and repeat the above-mentioned vacuuming process.

Note: The possible leakage points are the joints and welds.

pay attention:

After confirming that there is no leakage point, open the small valve core a little, when the pressure (low pressure) reaches 0.05MPa , close the small valve, and quickly remove the pressure gauge (very critical point).

Note: This step is to make the system become positive pressure, to prevent the air from entering again during the disassembly process, and the vacuuming failure

Open the pipeline:

First fully open the small valve, and tighten the valve back cover screw cap immediately after fully opening the large valve.

Note: Be sure to fully open the valve core so as not to affect the performance of the heat pump in the later stage.

Tighten the nut:

After the vacuuming is completed, be sure to install all the nuts and tighten them with a wrench to prevent refrigerant leakage.

And finally, the leak check:

Check each interface and stop valve at the connection of the working fluid pipe, apply a sponge block with soapy water to the suspicious point, and stay at each place for no less than 2 minutes. If bubbles are formed, there is a leak.

Note: The soapy water should not be too thin, otherwise it will affect the inspection; in summer, it should be checked for leaks in the shutdown state, and in winter, it should be checked during heating

Connected to the water tank



Schematic diagram of vacuuming

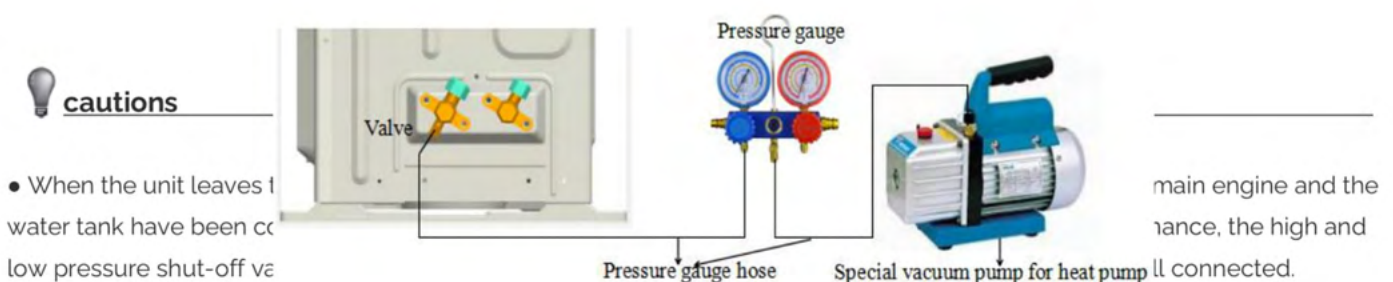

- Please use a vacuum pump to evacuate, and it is forbidden to use the refrigerant backflush of the host to evacuate

4-6 Water system installation

For water pipeline installation, please refer to 4-1 Pipeline Layout

- 1). The selection of pipe materials, stainless steel pipes, copper pipes, hot water aluminum-plastic pipes, hot water PPR pipes, etc. can be selected in line with national health and safety standards
Accurate, heat-resistant, rust-proof, and not easy to scale pipes.
- 2). Install a one-way valve at the water inlet of the water tank as shown in the figure.
- 3). The connection between the water tank and the water pipe must be equipped with a shut-off valve or a removable joint for use in maintenance.
- 4). The arrangement of the water pipes is reasonable, and the bending is minimized to reduce the resistance of the water system.
- 5). For metal pipes, high-density flame-retardant PE sponge must be used for thermal insulation.
- 6) . The water supply port must be equipped with a filter that meets the design flow requirements.

4-7 Electrical connections

- Electrical installation work may only be carried out by a licensed electrician in accordance with the relevant regulations on electrical safety and electrical wiring.
- Follow the wiring rules for circuit breaker rating and PRZEWOD thickness.
- The machine should use a special power supply, and the voltage should meet the rated voltage $\pm 10\%$
- The power supply circuit of the machine must have an effective ground wire, and the power ground wire must be reliably connected to the external ground wire.
- Power cables and signal cables should be arranged neatly and reasonably. Strong and weak cables should be separated from each other, and they should not interfere with each other. Otherwise, the normal state of the display will be affected.
- Please arrange the power supply layout reasonably and avoid splicing wires.
- Do not disconnect or disassemble the ground wire of the power supply under any circumstances; do not use damaged wires and switches, and replace them immediately if they are found to be damaged.

Please refer to the table below

POWER SPECIFICATION	WIRE DIAMETER	SWITCH	LEAKAGE PROTECTOR
220V~240V	1.5mm ²	16A	30mA

5 || system debugging

5-1 Preparation before operation

Operation without water in the water tank may cause the water heater to enter a protection state, which may damage components in severe cases.

In the event of such damage, the manufacturer will not be responsible for any damage caused by this issue.

Before trial operation, please follow the steps below:

- 1) Trial run must be done after all installations are complete
- 2) Before starting the machine, please confirm the following items, and mark them in the box after confirmation ✓

- correct installation
- The power supply voltage is consistent with the rated voltage of the unit
- Piping and wiring are correct
- The air inlet and outlet of the unit are barrier-free
- Drainage and emptying are smooth without leakage
- Leakage protector works effectively
- plumbing installed correctly
- grounding is valid

5-2 turn on power

cautions

Before turning on the power to the unit, double-check that the water tank is full of water.

- After confirming that the power cord is firmly connected, turn on the power of the water heater.
- No need to operate the display, the display is in the power-on state by default.
- The device has a three-minute delay start function, please be patient.

After running for 30 minutes, observe the running status, if there is any problem, please check the display

The fault code displayed on the screen and timely feedback;

- The device is fully automatic control, according to the selected method and the surrounding environment, the set water temperature, self-adaptive adjustment, heating the stored water to target temperature

5-3 Machine running dynamics

There are different heating times at different ambient temperatures.

Typically lower ambient temperatures result in longer heating times and thereformance.

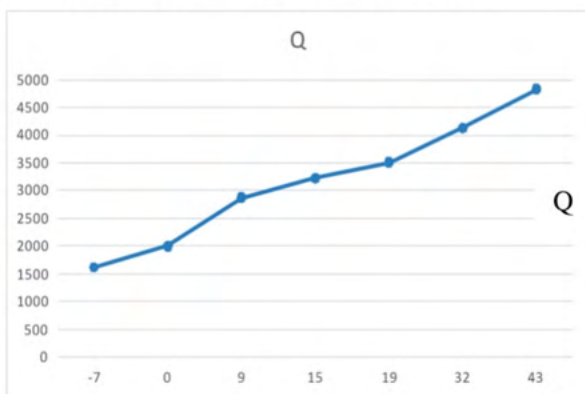

Changes in ambient temperature and heating capacity

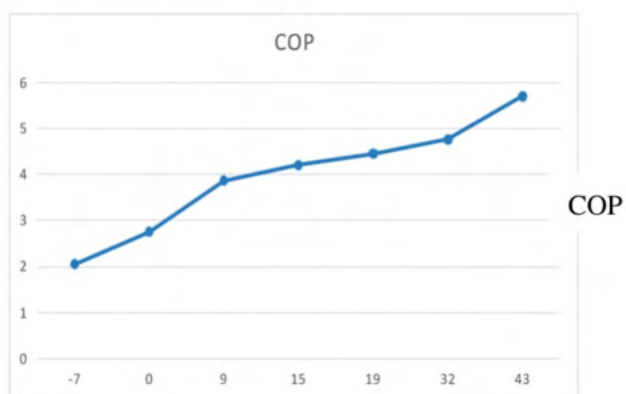

Changes in ambient temperature and energy efficiency ratio

Note: The above data is measured in the laboratory to simulate the ambient temperature and humidity. If it is different from the actual ambient temperature and humidity, this data for reference only.

5-4 protection method

- When the self-protection mode is activated, the system will stop and start self-checking.

Once the error is resolved, the unit will restart.

- When the self-protection mode is activated, the error code will be displayed on the screen until the error is resolved.

- The device can enter self-protection mode under various conditions, including but not limited to:

blocked air inlet or outlet;

The evaporator is covered with too much dust;

The unit receives incorrect power (over the 220-240v range)

5-5 Refrigerant addition

- The working medium pipe equipped with the main engine is the base length. When the length exceeds the base standard length, the refrigerant must be added strictly according to the length of the working medium pipe. Additional refrigerant is required.

Please follow the table below, adding more or less will affect the performance of the unit

REFRIGERANT ADDITION	RECORD
0.015kg/m× (L- base length)	

Note: L is the length of the double-pass working fluid tube, in m





- After adding, please record the final charging amount and keep it properly for subsequent maintenance

6 System operation

6-1 display









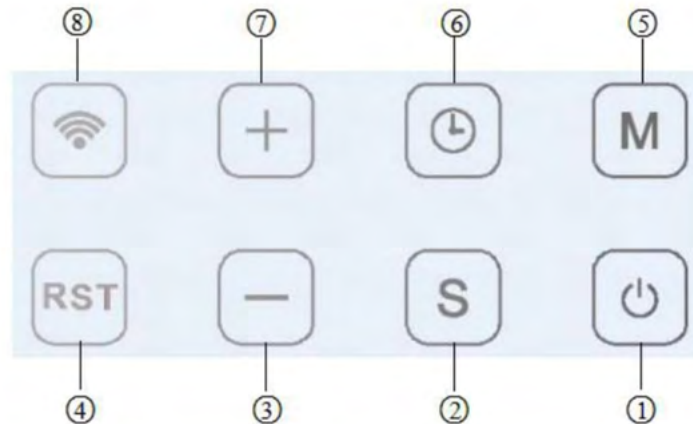

1		Lock: (this function is blocked) If the control panel is locked, the lock icon will be displayed on the screen
2	AUTO	Auto Mode: If auto mode is selected, this icon will be displayed on the screen
3	ECO	Economic model: This icon will be displayed on the screen if the economy mode status is selected
4	STANDBY	Insulation: If the machine stops working when the water temperature has reached the set temperature, this icon will be displayed on the screen
5	HEAT	Heating: This icon will be displayed on the screen when the machine is on and working to produce hot water

6	OFF	Shutdown: This icon will be displayed on the screen when the machine is off
7	ERR	Fault: When the machine automatically detects fault feedback, this icon will flash on the screen
8		Defrost: This icon will be displayed on the screen when the machine is in defrost state
9		Fan: This icon will appear on the screen when the fan is running
10		Water pump: This icon will appear on the screen when the pump starts working
11		Electric heating: When the electric heating tube starts to work, this icon will be displayed on the screen
12	OFF	Timed off: This icon will be displayed on the screen if the timed power-on function is canceled
13	ON	Open regularly: This icon will be displayed on the screen if the timed power-on function is performed
14	SET	Set temperature: When the desired unit temperature is set, the set temperature icon will be displayed on the screen
15		When the control panel is not working, the water temperature setting will display the current water temperature in the tank; when the desired temperature is set, the water temperature setting will display the desired temperature

6-2 The control panel



1		Start the device: Turn on the machine, and press and hold the power button for 3 seconds. The display "HEAT" flashes; Turn off the device: Turn off the machine, press and hold the switch for 3 seconds. Display "OFF" display;
2		Setting parameters: When you need to set the water temperature or other parameters, press this key to proceed; Press and hold for 10 seconds to enter forced defrost;
3		reduce: To lower the set temperature or reduce a certain value, press this key to proceed;
4		Reset: Press this key to reset to the original factory setting parameters;

5		model: Press and hold for 3 seconds to activate the electric heating function;
6		Time setting: press this key to set the current time; Set timed power on/off;
7		Increase: To increase the set temperature or increase a certain value, press this key to proceed;
8		This key is invalid

6-3 key operation instruction





start up :

- power on : press "" for 3 seconds
- power off : press "" for 3 seconds









Temperature set:

- press "+" or "-" to set the temperature and adjust temperature
- press "" to save your set and then quit.





Time set:

- press "" to set time as follows: hour -clock-quit
- press "" and "" to set the time details ;
- without pressing keys for 30 seconds ,the machine will quit automatically
- during the set process ,you can press "" to quit;

Timer switch set :

- press "" for 3S to come into the setting
- timing 1: timing 1 flicks,press "" and "" to set hours, and press "";timing 1 flicks,and press "" and "" to set the minutes , and press ""
- timing 2 : press "" to come into timing 2 ,and way is as the same as timing 1 ;
- timing 3: same way as above ;
- without any action for 30seconds ,it quit automatically ;
- press "" to quit if no action needed;

factory parameter setting:

- Press "(RST)" 3 times continuously to come in to the data setting ,press "" or "" to set and then press "" to confirm your setting .
- without any actions for 5 seconds ,the machine will quit automatically
- press "" to quit if you do want to do any action .

Parameters restore factory default parameters

- press "(RST)" for more than 4 seconds,when it shows "dEF", press "" to become factory default parameters

Manual forced defrost

- press "" for 10 seconds ,Then the defrosting is forced to start, and the maximum defrosting time is reached or the protection fault exits.

- press "S" for 3 times continuously , press "▲" or "▼" to come to Fg8, then press "S" to show "AdF", After the machine is started, first close the low-pressure shut-off valve, then close the high-pressure shut-off valve after the machine runs for 1 minute, and finally press any key to exit this mode
- Disconnect the power supply to prevent the machine from starting up in the event of a system blockage

Legionella control method – provide details of control strategy:

- Compressor opens automatically at 2:00 a.m. every monday(constant temperature shutdown and standby status can be opened);
- Disinfect once a week;
- The default is: 61 °C, 32 min;

7 System Trouble shooting

7-1 Fault code

	CONTENT	FAULT CODE	HEAT PUMP STATUS	NOTES
①	Freeze Protection	A11		
②	Low voltage switch protection	A12	stop heating	power off then power on
③	High voltage switch protection	A13	stop heating	power off then power on
④	Water tank temperature sensor failure	A21	stop heating	Automatic recovery
⑤	Coil temperature sensor failure	A22	-	Automatic recovery
⑥	Exhaust temperature sensor failure	A23	-	Automatic recovery
⑦	Ambient temperature sensor failure	A25	-	Automatic recovery
⑧	Intake air temperature sensor failure	A26	-	Automatic recovery
⑨	Operator cable interruption protection	A51	stop heating	When the VCC and GND lines are opened, the operator does not light up; when the A and B lines are opened, the operator displays the A51 fault code
⑩	Exhaust temperature high temperature protection	A61	stop heating	3 times/hour the heat pump stops working

7-2 trouble shooting

PROBLEMS	REASONS	SOLUTION	PHENOMENON
Freeze protection A11	Water temperature ≤ 4 °C for more than 5 minutes or ambient temperature ≤ 2 °C and the shutdown time exceeds 15 minutes	Make sure the water volume of the water tank, the machine will automatically detect and return to normal.	
Low voltage switch protection A12	1. The terminals of the low-voltage switch fall off or have poor contact or are damaged;	1. Check the circuit board port;	After 3 occurrences within 1 hour, the machine will automatically stop working, and it needs to be powered on again to resume the

			re-detection;
	<p>2. Lack of snow seeds;</p> <p>3. The ambient temperature is lower than -7°C;The electronic expansion valve is not open;</p>	<p>2. Check whether the operating pressure is lower than the standard value of the pressure switch;</p> <p>3. The working environment has exceeded the limit operating range of the compressor;</p> <p>Check whether the electronic valve coil and port are loose;</p>	
High voltage switch protection A13	<p>1. The terminal of the high-voltage switch has fallen off or is in poor contact or is damaged;</p> <p>2. Water shortage (the pump does not work);</p> <p>3. The filter is blocked;</p> <p>4. The electronic expansion valve is not opened;</p> <p>The water tank temperature sensor is not placed in the water tank, resulting in a misjudgment, which does not match the actual water temperature;</p>	<p>1. Check the port of the circuit board;</p> <p>2. Check the amount of water or whether the pump is Work;</p> <p>3. Enter the forced defrosting function, reverse the flush for 1 min;</p> <p>4. Check the coil and end of the electronic valve Whether the mouth is loose;</p>	After 3 occurrences within 1 hour, the machine will automatically stop working, and it needs to be powered on again to resume the re-detection;
Tank temperature sensor A21	1、break or short circuit ;	1、 Replace the sensor	Machine stop working
Coil temperature sensor A22	1、break or short circuit;	1、 Replace the sensor	The machine can run normally, but cannot enter or exit the defrost
Exhaust temperature sensor A23	1、break or short circuit;	1、 Replace the sensor	The machine can run normally, but the high temperature protection fails
Environment temperature sensor A25	1、break or short circuit;	1、 Replace the sensor	Machine works normally, but cannot enter or exit the defrost
Suction temperature sensor A26	1、break or short circuit;	1、 Replace the sensor	Machine works normally
Operator cable interruption protection A51	1. The connecting line of the operator is open or short-circuited	1、 Replace the sensor	When the VCC and GND lines are connected, the operator does not light up;

			when the A and B lines are connected, the operator displays the A51 fault code, and the machine stops working;
Exhaust temperature high temperature protection A61	1. Lack of snow seeds; Water shortage (pump not working)	1. Check whether the system lacks refrigerant, check the system leaks and make up for them in time; Check the water volume of the water tank and whether the pump is running;	After 3 occurrences within 1 hour, the machine will automatically stop working, and it needs to be powered on again to resume the re-detection;

Shows running, but not heating	1. The compressor does not work (overload or burn out); 2. Four-way valve gasping; 3. In the cooling state defrosting); lack of snow seeds;	1. Check whether the compressor line is loose and measure whether the resistance of the compressor main winding and auxiliary winding is normal; 2. Judgment of panting of the four-way valve: check if the temperature of the exhaust pipe is the same as the temperature of the intake pipe, it is regarded as a panting phenomenon; Judgment of cooling status: the water temperature continues to cool down; the fan continues to blow hot air
Heating, fan not running	1. The motor capacitor is damaged; The motor is burned out or the power cord is loose;	Replace the motor or capacitor
Compressor is noisy	1. Water shortage (the pump does not work), the temperature difference is too large; 2. The compressor is fixed too tightly, and the rubbing vibration space is small; The operating voltage	1. Ensure that there is sufficient water; 2. The distance between the control nut and the top of the compressor damping rubber; Increase the voltage regulator to ensure that the voltage is normal;
Product is noisy	1. The pipeline vibrates greatly; If the distance between the parts is too small, it is easy to cause collision and friction;	1. Vibration-absorbing rubber is added to the pipe fittings; Adjust the distance between components and pipes.
User temperature is low	1. The amount of cold water mixed with water is large, and the output of hot water is small;	1. Adjust the mixing valve to control the ratio output of hot water and cold water;

The diagnostic codes and usage symptoms listed above are the most common, if the diagnostic codes listed above or other usage issues do not appear, please contact technical assistance

8 | system maintenance

8-1 cleaning

The heating effect depends on whether there is dust, mud or the surface of the evaporator

The sundries block the air inlet channel and lose the effect of exchange with the air, resulting in heating efficiency.

It is necessary to clean the dust or other impurities on the the evaporator in time to ensure that the Air intake and blowing unobstructed

- Be sure to turn off the heat pump unit before cleaning (disconnect the power supply directly)
- Water flushing: first wash away the dust or other impurities on the surface
- Air conditioner special cleaning agent: choose special cleaning agent for air conditioner fins, evenly Spray on the surface of the fin for more than 0.5h (determined by the thickness of the dust)
- If necessary, use a special brush for cleaning air conditioners to brush the fins (to prevent rewinding)
- Water flushing: Rinse off the dust on the fins with clean water again
- Check whether there are water droplets on the electronic control components, and then turn on the power supply and start the operation after ensuring safety.



8-2 Clean water tank fouling

Water tank fouling is easy to affect water quality, serious will cause the heating efficiency of the machine, it is recommended to clean once every two months:

- Turn off the heat pump unit (disconnect the power supply directly)
- turn off ④ stop valve ,and turn on faucets in home
- turn on ⑥ stop valve to drain the tank
- after first drainage,turn on ④ stop valve ,and turn off ⑥ stop valve to fill in with water ,and then drain it out to see the water cleanliness ; you can repeat these operation if needed
- after cleaning ,turn on ④ stop valve ,and turn off ⑤ stop valve ;
- Be sure to fill the storage tank with water before turning on the power and starting the heat pump unit

8-3 Check the anode and replace it every six months

Check the anode and replace if necessary (frequency: every six months,

Anodically protect the lining of the hot water tank. As the anode deteriorates, the degree of protection decreases.

It is recommended to periodically check the anode for degradation and replace the anode if needed

- Turn off the heat pump unit (disconnect the power supply directly)
- turn off the stop valve ④ and turn on the stop valve ⑤ ; and faucet to drain the tank
- Locate the anode position and unscrew the anode cover
- Use an Allen wrench to loosen
- Check the consumption of the anode, if it is used up, it needs to be replaced immediately, so as not to affect the quality of the water
- To restore the state of use, be sure to fill up the water first and observe whether there is any leakage
- Turn on the power, turn on the heat pump to heat the water to the termination temperature, and then observe whether there is any leakage here,before leaving

8-4 PTR maintenance

Operate the valve (frequency: replace every six months)

Periodic operation of the valve is recommended to ensure smooth water flow.

If the water does not flow freely, more

Change valve.

In order to avoid the expansion and deformation of the water tank due to excessive pressure, the service life of the water tank will be affected.

- Find the position of the valve
- Carefully release the valve with the lever to release some water from the tank.



Note: Please use the water discharged from the container to avoid damage to other items

- If the water is flowing, the valve is still in proper working order
- If the water does not flow freely, the valve is out of function and needs to be replaced
- If the valve needs to be replaced, please contact your plumber or our service team for further assistance

8-5 check

1. Please check the machine regularly for any damage, if there is obvious damage, please contact our maintenance team.

2. In some cold areas (below zero degrees Celsius), if the system stops working for a long time, all the water in the water tank should be released and re-installed in the water tank.

Reuse before filling with water to prevent the inner box from freezing.

Failure to do so may cause the machine to malfunction and, in severe cases, damage

★8-6 Water quality requirements for water supply (chloride and pH)

In areas of water supplies with high chloride levels, water can corrode certain parts, causing them to fail.

Not suitable for heat pump units and storage tank units if the chloride content exceeds 200 mg/L.

pH is a measure of whether water is alkaline or acidic.

Heat pump units and hot water tank units with a Ph value less than 6.0 are not guaranteed.

The water supply to rainwater storage tanks within urban agglomerations can be corrosive due to the dissolution of atmospheric pollutants.

Water with a pH value of less than 6.0 can be treated to increase the pH value, so it is recommended to analyze the quality of tap water before connecting to this type of water supply system.

pH & CHLORIDES

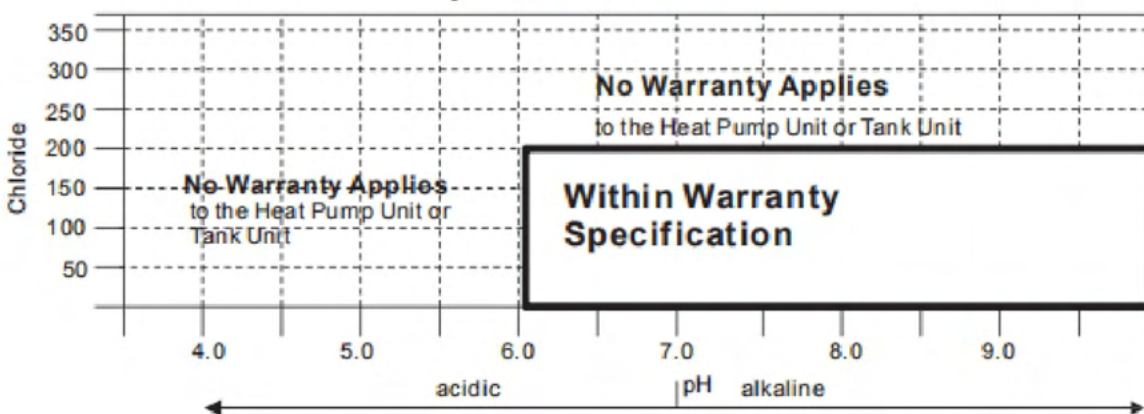

9|The warranty

9-1 Warranty Policy Warranty Conditions

- 1) The ECOGENICA Heat Pump Water Heater System must be installed in accordance with the installation instructions supplied with the Heat Pump Water Heater System, and in accordance with all relevant statutory/local requirements of the state/province/municipality in which the water heater is installed.
- 2) Where a failed component or Heat Pump Water Heater System is replaced under warranty, the balance of the original warranty period will remain effective. The replaced part or Heat Pump Water Heater System does not carry a new warranty.
- 3) Where the Heat pump Water Heater System is installed in a position that does not allow safe, ready access, the cost of accessing the site safely, including the cost of additional materials handling and/or safety equipment, shall be the owner's responsibility.
- 4) The warranty only applies to the Heat Pump Water Heater System and original or genuine (company) component replacement parts and therefore does not cover any plumbing or electrical parts supplied by the installer and not an integral part of the Heat Pump Water Heater System. Such parts would include pressure regulating valve, isolation valves, check valves, electrical switches, pumps or fuses.
- 5) The Heat pump Water Heater System must be sized to supply the hot water demand in accordance with the guidelines in the ECOGENICA Heat Pump Water Heater System Literature.
- 6) This warranty is for parts only, any and all labor costs associated with diagnosis, removal of the faulty part and installation of replacement parts will solely be the owner's responsibility.

Warranty Exclusions

1. Repair and replacement work will be carried out as set out in the ECOGENICA Heat Pump Water Heater System warranty. However, the following exclusions may void the warranty and may incur additional service charges and/or cost of parts
2. Accidental damage to the Heat Pump Water Heater System or any component, including: Acts of God, failure due to misuse, incorrect installation, attempts to repair the water heater other than by a ECOGENICA accredited service agent or the ECOGENICA service department.
3. Where it is found there is nothing wrong with the Heat Pump Water Heater System; where the complaint is related to excessive discharge from the temperature and/or the pressure relief valve due to high water pressure; where there is no flow of hot water due to faulty plumbing; where water leaked are related to plumbing and not the Heat Pump Water Heater System or its components; where there is a failure of electricity or water supplies; where the supply of electricity or water does not comply with relevant codes or acts.
4. Where the Heat Pump Water Heater System or its component has failed directly or indirectly as a result of excessive water pressure.
5. Overflow vent drain has not been installed or blocked or corroded.
6. Where the Heat Pump has rusted as a result of a corrosive atmosphere.
7. Where the unit fails to operate or fails as a result of ice formation in the piping to or from the Heat Pump Water Heater System.
8. Where the Heat Pump Water Heater System is located in a position that does not comply with the Heat Pump Water Heater System installation instructions or relevant statutory requirements, causing the need for major dismantling or removal of cupboards, doors or walls, or use of special equipment to bring the Heat Pump Water Heater System to floor or ground level or to a serviceable position.
9. Repair and/or replacement of the Heat Pump Water Heater System due to scale formation above 200ppm (water hardness) in the waterways or the effects of either corrosive water or water with a high chloride or low PH level when the water heater

Installation Diagram – SwiftConnect

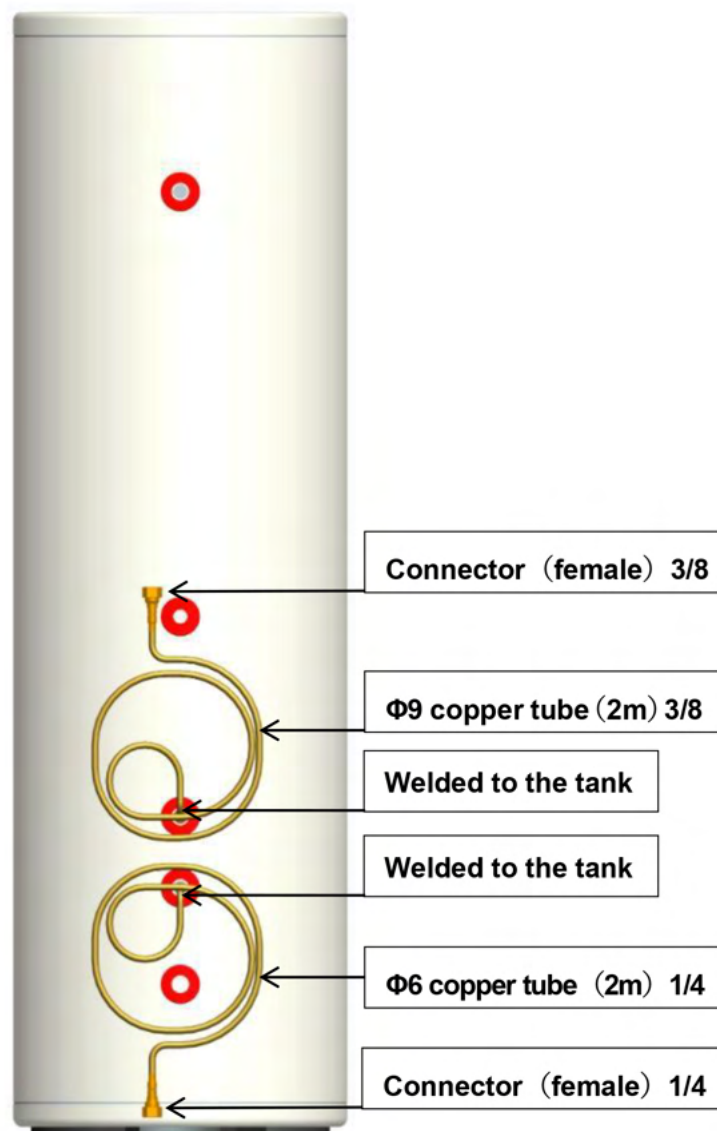
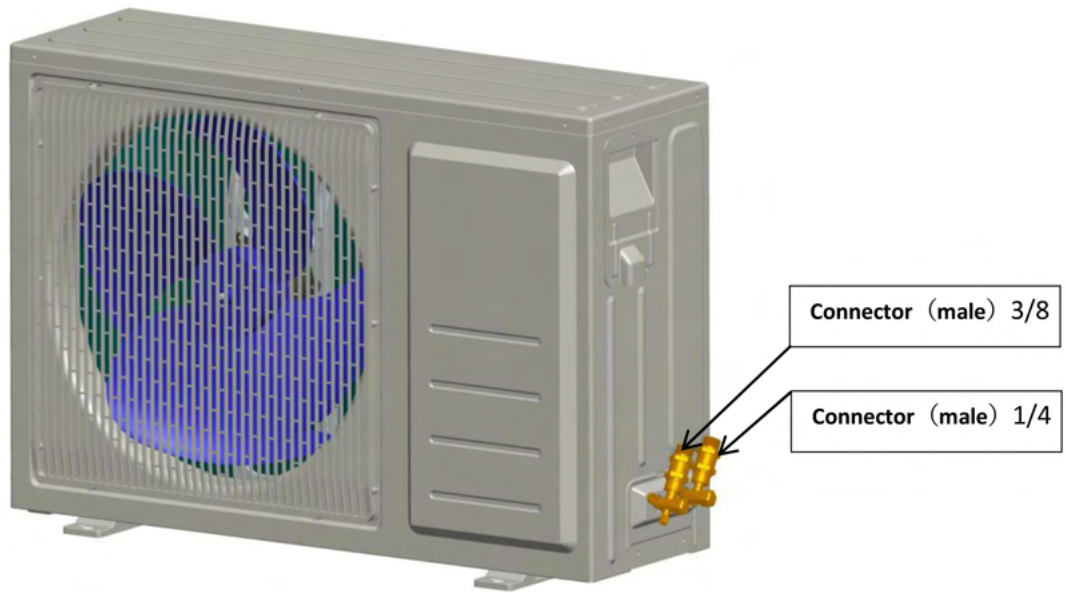

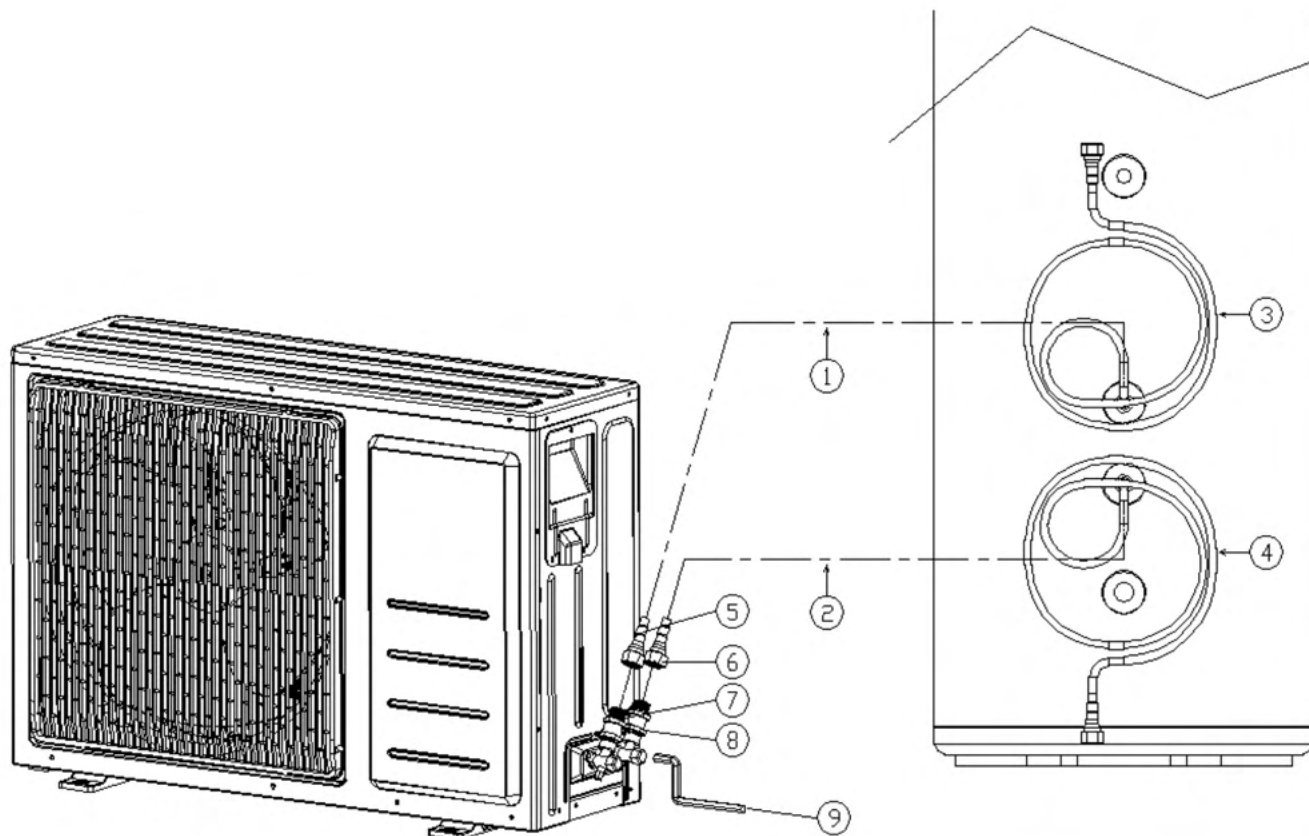

Installation Diagram – SwiftConnect

③ Φ 9 copper tube (2m) ④ Φ 6 copper tube (2m) ⑤ connector (female) 3/8 ⑥ connector (female) 1/4
 ⑦ connector (male) 3/8 ⑧ connector (male) 1/4 ⑨ hexagon spanner

Installation instructions:

- 1、Copper tube③④already welded to the tank and filled refrigerant.
- 2、Please choose a correct position before connecting ③ ④ the copper tubes to condenser box.
- 3、Make sure the connector (male) is connected to the connector (female). Please use a hexagon spanner to open-up the refrigerant valve.
- 4、Please check and make sure there is no refrigerant leak.